

StabilityPlus™ Low-Profile Microwave/RF Cable Assemblies

DATA SHEET / 2Z-010

THE INDUSTRY'S BEST PHASE STABLE CABLE ASSEMBLY JUST GOT BETTER!



MODELS:

SP-185-LP // 1.85mm color-coded StabilityPlus™ low-profile cables

SP-24-LP // 2.4mm color-coded StabilityPlus™ low-profile cables

SP-292-LP // 2.92mm color-coded StabilityPlus™ low-profile cables

SP-35-LP // 3.5mm color-coded StabilityPlus™ low-profile cables

SP-N-LP // Type N color-coded StabilityPlus™ low-profile cables

SP-TNCA-LP // TNCA StabilityPlus™ low-profile cables



StabilityPlus™ Low-Profile Microwave/RF Cable Assemblies

SERIES SP-185-LP, SP-24-LP, SP-292-LP, SP-35-LP, SP-N-LP, AND SP-TNCA-LP

Features and Benefits

- > Stable and repeatable electrical performance
- > Small profile for tight spacing requirements
- > Flexible to facilitate easy installation
- > Lightweight for use with smaller DUTs
- > Color-coded connectors to avoid damage caused by connector mismates

Typical Applications

- > Wafer probing
- > Test bench systems
- > RF and microwave instruments
- > ATE systems
- > Switch matrices
- > R&D and prototyping



Description

Maury Microwave's StabilityPlus™ Low Profile Microwave/RF Cable Assemblies feature the same excellent electrical performance as our ruggedized StabilityPlus™ cables, but with a more compact and flexible design. StabilityPlus™ Low Profile cables provide excellent phase and amplitude stability with flexure resulting in highly reliable, repeatable measurements. They are ideal for applications that require lighter weight or tighter spacing such as wafer probing, ATE systems and switch matrices.

StabilityPlus™ cable assemblies are now part of the ColorConnect™ family! Following the proposed IEEE high-frequency connector/adaptor color convention, StabilityPlus™ cable assemblies are the first commercially available assemblies to offer clear indications of compatibility and intermatability. ColorConnect™ makes it a simple matter to avoid and eliminate damaged equipment, degraded equipment reliability, degraded performance and lengthy maintenance times due to improper mating (and attempted mating) of incompatible interconnects.

Stability™ Specifications

StabilityPlus™ Low-Profile Cable Type	Frequency	Typical Phase Stability with Flexure	Typical Amplitude Stability with Flexure
SP-185-LP	67 GHz	±8°	±0.15 dB
SP-24-LP	50 GHz	±6°	±0.05 dB
SP-292-LP	40 GHz	±4.5°	±0.05 dB
SP-35-LP	26.5 GHz	±3°	±0.05 dB
SP-N-LP	18 GHz	±2°	±0.05 dB
SP-TNCA-LP	18 GHz	±2°	±0.05 dB

Standard Cable Assembly Specifications

StabilityPlus™ Low-Profile Cable Type	SP-185 LP	SP-24 LP	SP-292 LP	SP-35 LP	SP-N LP & SP-TNCA LP
Maximum Frequency	67 GHz	50 GHz	40 GHz	26.5 GHz	18 GHz
VSWR (typical)	1.40:1	1.30:1	1.25:1		
Typical Insertion Loss (cable only)	1.79 dB/ft	1.00 dB/ft	0.89 dB/ft	0.72 dB/ft	0.61 dB/ft
Phase Stability vs Flexure (typical)	±8°	± 6°	± 4.5°	± 3°	± 2°
Phase Stability vs Flexure (maximum)	±14°	± 10.5°	± 8.5°	± 5.5°	± 4.2°
Amplitude Stability vs Flexure (typical)	±0.15 dB	± 0.05 dB			
Amplitude Stability vs Flexure (maximum)	±0.20 dB	± 0.10 dB			
Phase Stability vs Temp	<4°/m/GHz (-55°+105°C)				
Impedance (nominal)	50 ohm				
Velocity of Propagation	74% (nominal)	76% (nominal)			
Shielding Effectiveness	>90 dB (DC - 18 GHz)				
Time Delay (nominal)	1.34 ns/ft (4.5 ns/m)				

Mechanical / Environmental Properties

StabilityPlus™ Low-Profile Cable Type	SP-185-LP	SP-24-LP, SP-292-LP, & SP-35-LP	SP-N LP	SP-TNCA LP
Center Conductor Material	Silver Plated Copper			
Maximum Outer Diameter (Connector)	0.37 in (9.5mm)	0.38 in (9.6mm)	0.870 in (22mm)	0.64 in (16.25mm)
Maximum Outer Diameter (Cable)	0.1 in (2.6mm)	0.14 in (3.6mm)		
Nominal Weight	0.237 oz/ft (22g/m)	0.38 oz/ft (35g/m)		
Min. Static Bend Radius/ Min. Dynamic Bend Radius	0.51 in (13mm)/1.1 in (28mm)	0.55 in (14mm)/1.4 in (36mm)		
Flex Life Cycles	>15,000			
Connector Mating Cycles	>5,000			
Crush Resistance	>23 lbf/in (4 kgf/cm)			
Operating Temperature Range	-67°F to 221°F (-55°C to 105°C)			
RoHS/REACH	Yes			

**Maury StabilityPlus™ Cable
Assembly Typical Performance**

*Maury StabilityPlus™
Low-Profile 36" Cable
Assembly Typical
VSWR*

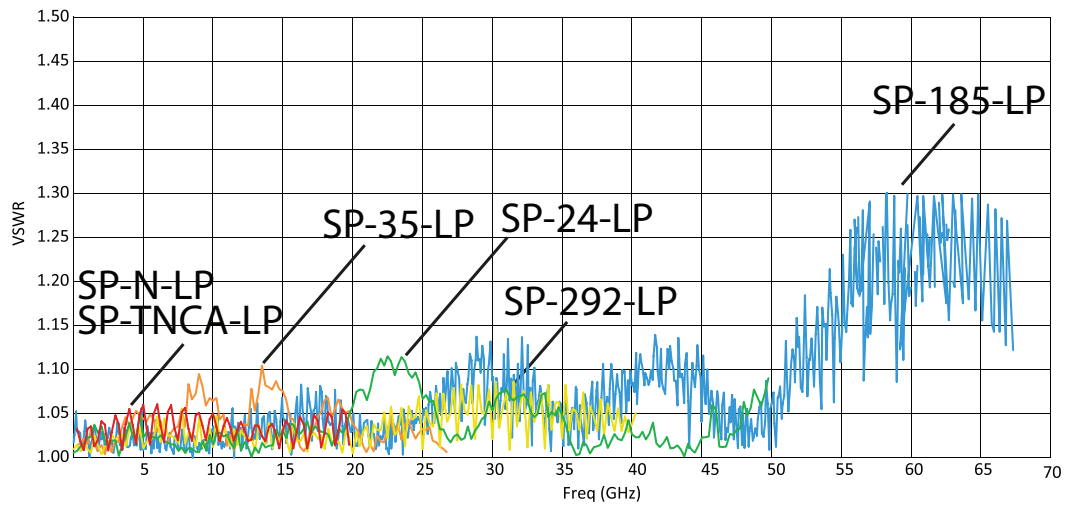

*Maury StabilityPlus™ Low-Profile 36" Cable Assembly
Typical Insertion Loss*

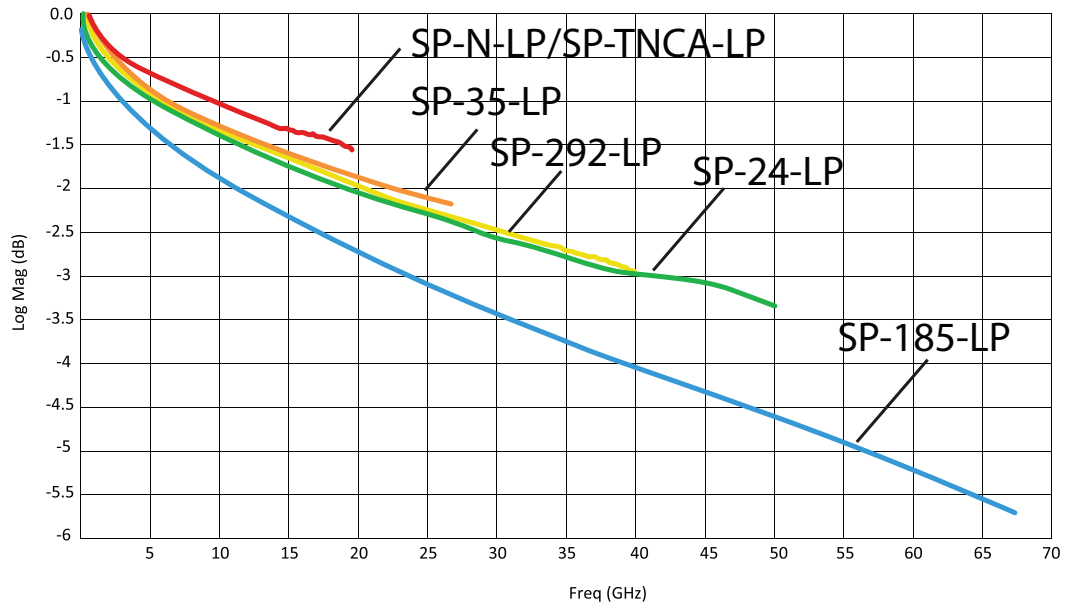

Max Insertion Loss/Attenuation

(1:1 VSWR, 25 C, Sea Level, Cable Only)

Freq (GHz)	SP-185-LP (dB/100 ft)	SP-24-LP (dB/100 ft)	SP-292-LP (dB/100 ft)	SP-35-LP (dB/100 ft)	SP-N-LP (dB/100 ft)	SP-TNCA-LP (dB/100 ft)
1	19.20	13.3	13.3	13.3	13.3	13.3
2	27.37	19.00	19.00	19.00	19.00	19.00
4	39.14	27.00	27.00	27.00	27.00	27.00
6	48.35	33.20	33.20	33.20	33.20	33.20
8	56.23	38.40	38.40	38.40	38.40	38.40
12	69.70	47.40	47.40	47.40	47.40	47.40
18	86.57	58.50	58.50	58.50	58.50	58.50
26.5	106.77	71.60	71.60	71.60	—	—
40	133.94	88.90	88.90	—	—	—
50	151.70	100.10	—	—	—	—
67	179.00	—	—	—	—	—

Average Power Handling

(1:1 VSWR, 25 C, Sea Level, Cable Only)

Freq (GHz)	SP-185-LP Watts (Max)	SP-24-LP Watts (Max)	SP-292-LP Watts (Max)	SP-35-LP Watts (Max)	SP-N-LP Watts (Max)	SP-TNCA-LP Watts (Max)
1	271	409	409	409	409	409
2	190	288	288	288	288	288
4	133	202	202	202	202	202
6	108	165	165	165	165	165
8	93	142	142	142	142	142
12	75	115	115	115	115	115
18	60	93	93	93	93	93
26.5	49	76	76	76	—	—
40	39	61	61	—	—	—
50	34	55	—	—	—	—
67	29	—	—	—	—	—

**StabilityPlus™ Low
Profile Dimensions**

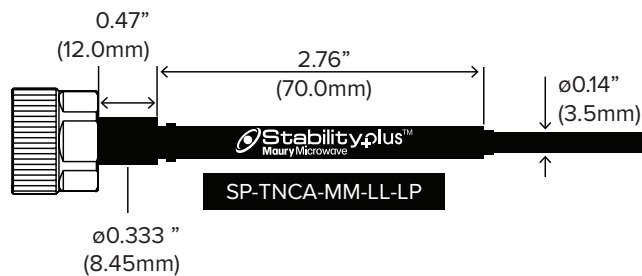
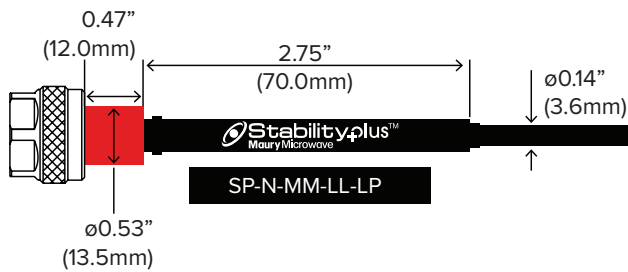
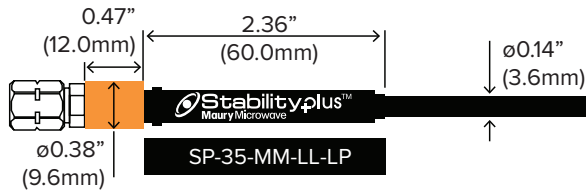
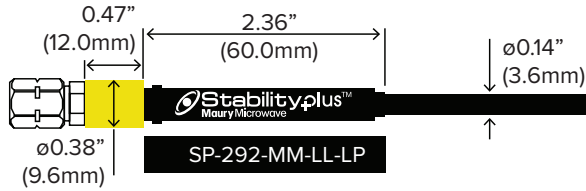
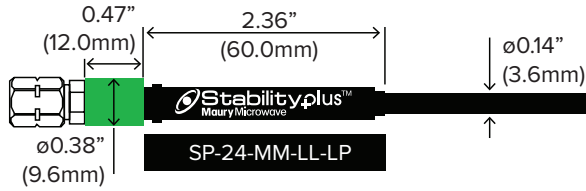
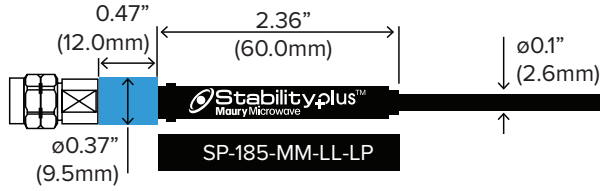

Phase Stability

The maximum value for phase and amplitude stability was established using the following method. The cable was terminated with a short. With the cable in a straight position the VNA was normalized. The cable was then coiled 360° around a mandrel 4 inches in diameter counter-clockwise and held in position for one sweep. The maximum deviation over the frequency range was recorded. The cable was then coiled 360° around the mandrel clockwise and held in position for one sweep and the maximum deviation was recorded. The cable was then returned to its original position for one sweep and the maximum deviation was recorded.

The plots on the right show the recorded worst-case phase variation.

Exemplary data for
SP-185-MM-36

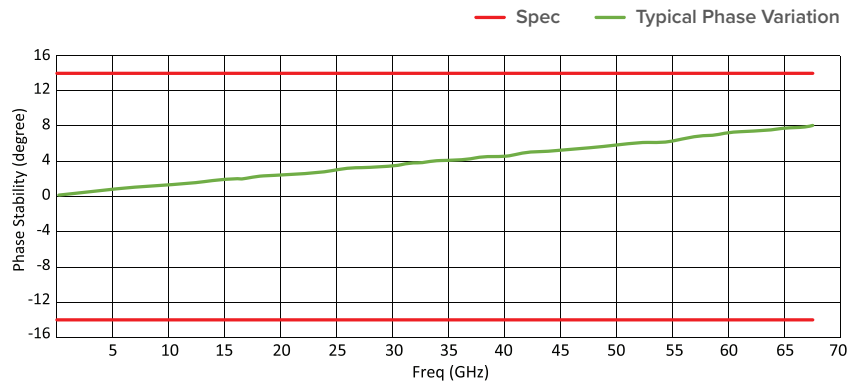

Exemplary data for
SP-24-MM-36-LP

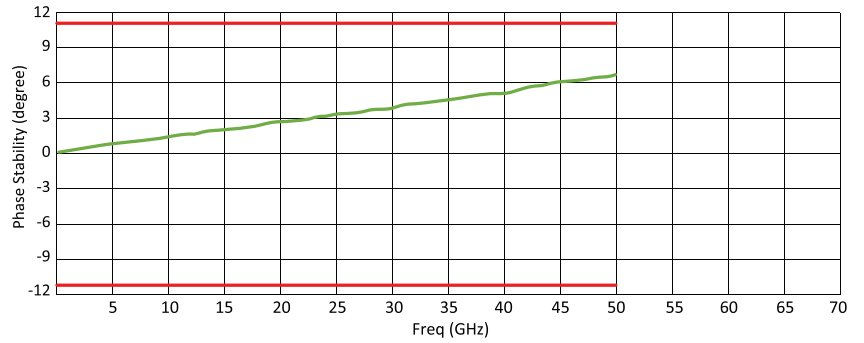

Exemplary data for
SP-292-MM-36-LP

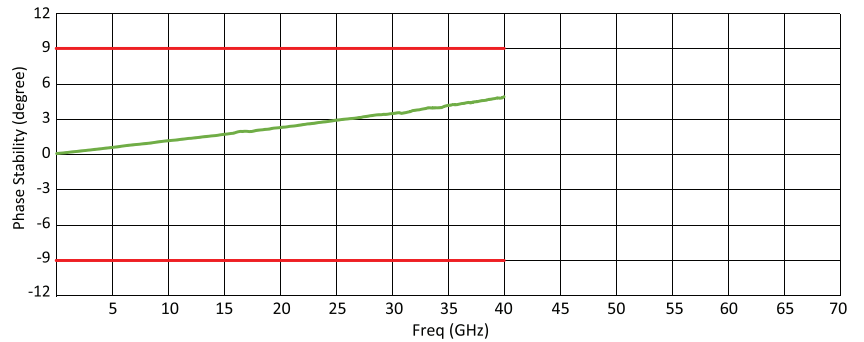

Exemplary data for
SP-35-MM-36-LP

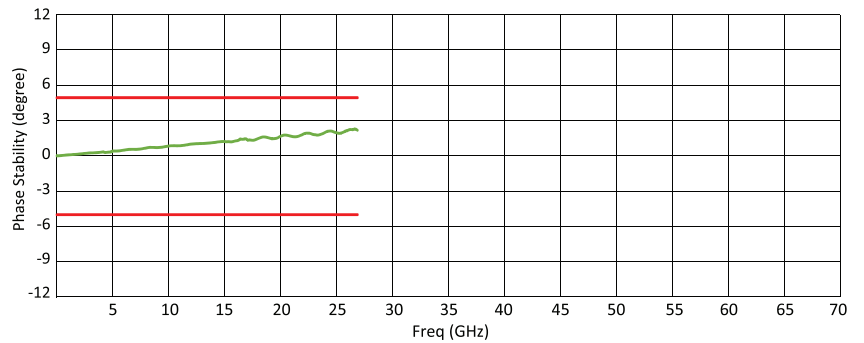

Exemplary data for
SP-N-MM-36-LP/
SP-TNCA-MM-36-LP

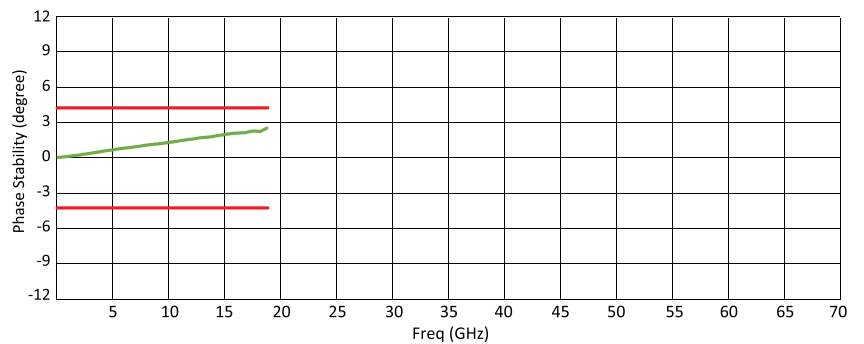

S-parameter measurements with uncertainty

A cable's *phase stability with flexure* specification is a metric used to communicate the impact of cable movement on a DUT measurement. It implies that lower specifications lessen the impact on the measurement (i.e. a cable with a 2° phase stability with flexure specification will have a lesser impact on a measurement than a cable with a 5° phase stability). However, the methods used to determine this specification may not be consistent across manufacturers, and likely do not represent the actual cable movement range of a user.

A better metric to understand a cable's impact on a DUT measurement is "uncertainty contribution". The cable's impact on measurement uncertainty can be calculated by moving the cable through a user's actual range of motion and recording the S-parameters across the movement. This technique has been thoroughly documented by the European Association of National Metrology Institutes (EURAMET)* and has been made commercially available in Maury's Insight™** calibration and measurement software platform.

The plots on the right show typical S-parameter measurements with uncertainty boundaries on different types of DUTs. The boundaries shown only consider the cable's direct contribution on measurement uncertainty.

* <https://www.maurymw.com/pdf/I-CAL-GUI-012.pdf>

** https://www.maurymw.com/Precision/Insight_Software.php

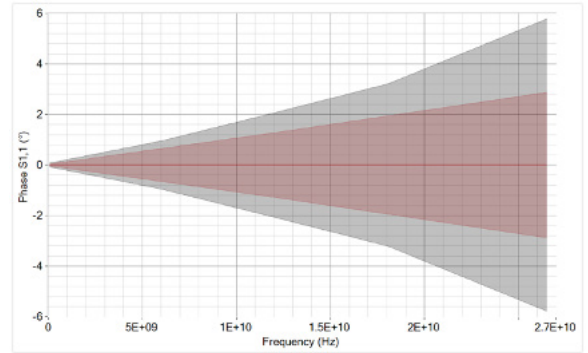

*S11_phase measured on a short circuit termination
SP-35-MM-36-LP shown in red; leading global
competitor shown in grey*

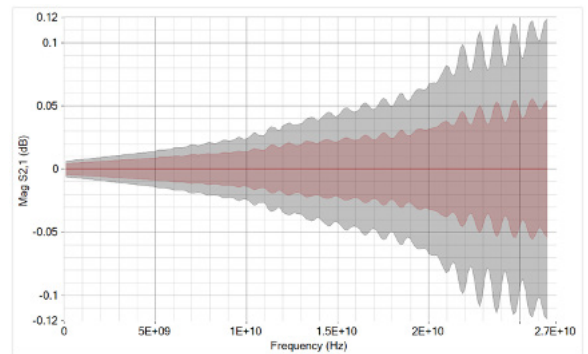

*S21_mag measured on an airline
SP-35-MM-36-LP shown in red; leading global
competitor shown in grey*

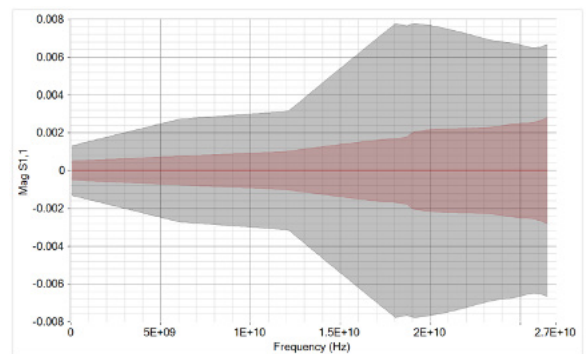

*S11_mag measured on a 50Ω termination
SP-35-MM-36-LP shown in red; leading global
competitor shown in grey*



Ordering Instructions for StabilityPlus™ Low-Profile Cable Assemblies

Standard StabilityPlus™ Low-Profile Cable Assemblies

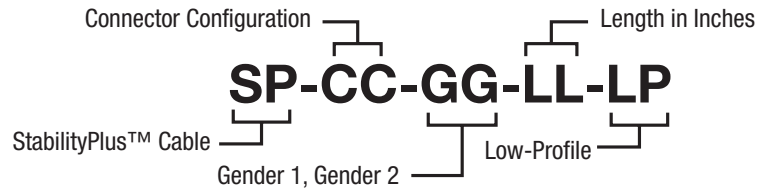

CC	GG	LL (Standard Lengths)	Low-Profile
TNCA			
N (Type N)*		24	
35 (3.5mm)	MM (Male To Male)	36	
292 (2.92mm)	MF (Male to Female)	48	LP (Low-Profile)
24 (2.4mm)	FF (Female To Female)	60	
185 (1.85mm)		78	

* Type N available in male only

EXAMPLE:

The following is a StabilityPlus™ Low-Profile cable assembly with 2.4mm male connector on one end and 2.92mm male connector on the other end, and 36 inches overall length.

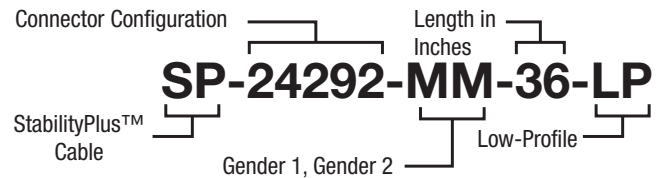

EXAMPLE:

The following is a StabilityPlus™ Low Profile cable assembly with 2.92mm male connector on one end and female connector on the other end, and 48 inches overall length.

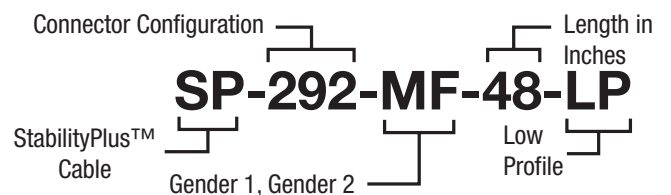

StabilityPlus™ Phase-Matched (PM) Cable Assembly Sets

StabilityPlus™ Phase-Matched Cable Assemblies have been designed for applications where strict phase equality between multiple paths are required. StabilityPlus™ PM Cable Assemblies are matched within $\pm 0.5^\circ/\text{GHz}$ and available as sets of two or more assemblies. StabilityPlus™ PM Cable Assemblies are offered in both standard and low-profile formats and maintain the mechanical and electrical characteristics of the original assembly. Phase-matched assemblies are available with 1.85mm, 2.4mm, 2.92mm, 3.5mm and Type-N connectors and in all lengths.

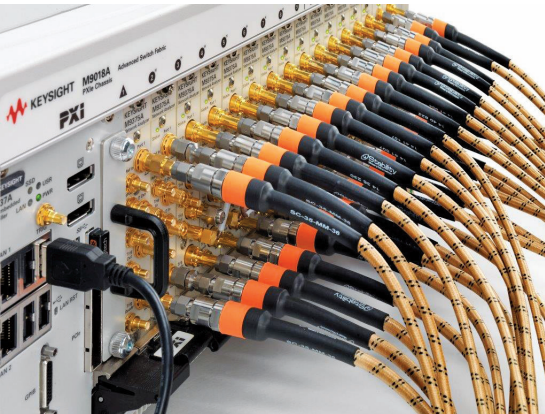
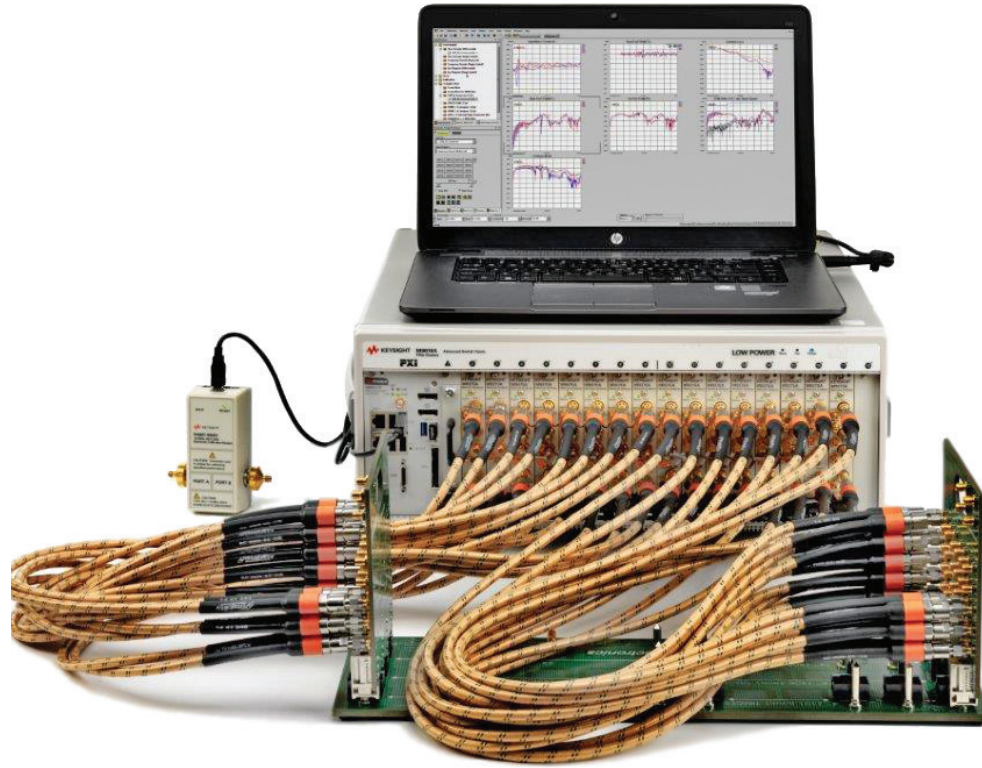

Ordering Instructions for StabilityPlus™ Phase-Matched (PM) Cable Assembly Sets

To specify a StabilityPlus™ Phase-Matched Cable Assembly set, add "PM" or "LPPM" at the end of the SP model number, as shown in the example below. "PM" indicates standard configuration Phase-Matched sets; "LPPM" indicates Low Profile configuration, Phase-Matched sets.

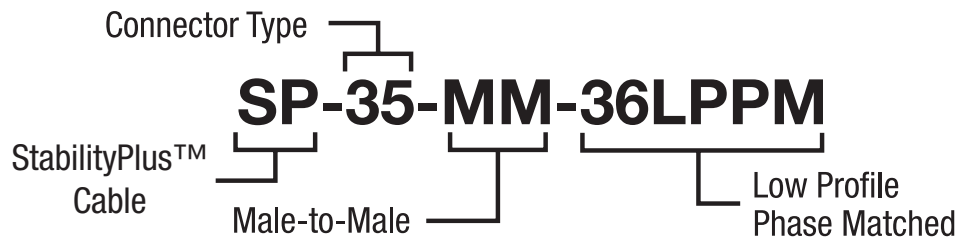

StabilityPlus™
Low-Profile Cable
Assemblies —
Swept Right-Angle

StabilityPlus™ Low-Profile Cable Assemblies with swept right-angle connectors are designed for applications requiring a fixed and stable bend where traditional cable assemblies may be inconvenient. With a bend radius of 0.5 inches and a cable-to-connector length of 2 inches, right-angle connectors allow StabilityPlus™ Low-Profile Cable Assemblies to retain the electrical and mechanical specifications of the traditional assembly while removing stresses related to hand-formed bends. StabilityPlus™ Low-Profile assemblies with swept right-angle connectors are built on demand and are available with 1.85mm, 2.4mm, 2.92mm, 3.5mm and Type-N connectors.

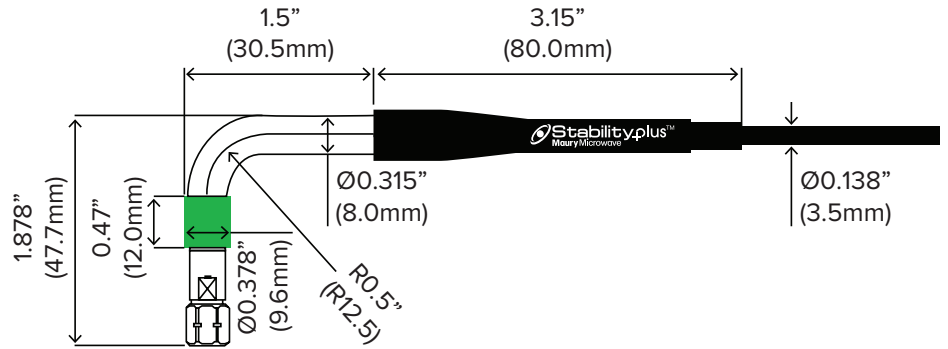

CC	G	LL
TNCA N (Type N) 35 (3.5mm) 292 (2.92mm) 24 (2.4mm) 185 (1.85mm)	M (Male) MR (Male swept right-angle) F (Female) FR (Female swept right-angle)	Custom length

Example:

The following is a StabilityPlus™ Low-Profile cable assembly with one 2.92mm male connector and one 2.4mm male swept right-angle connector, and 36 inches overall length.

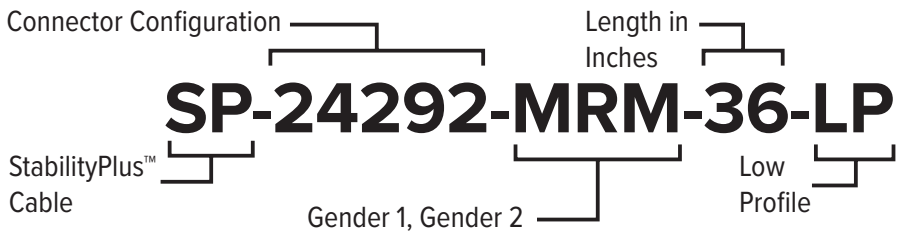

VISIT OUR WEB STORE
TO LEARN MORE ABOUT
OUR PRODUCTS

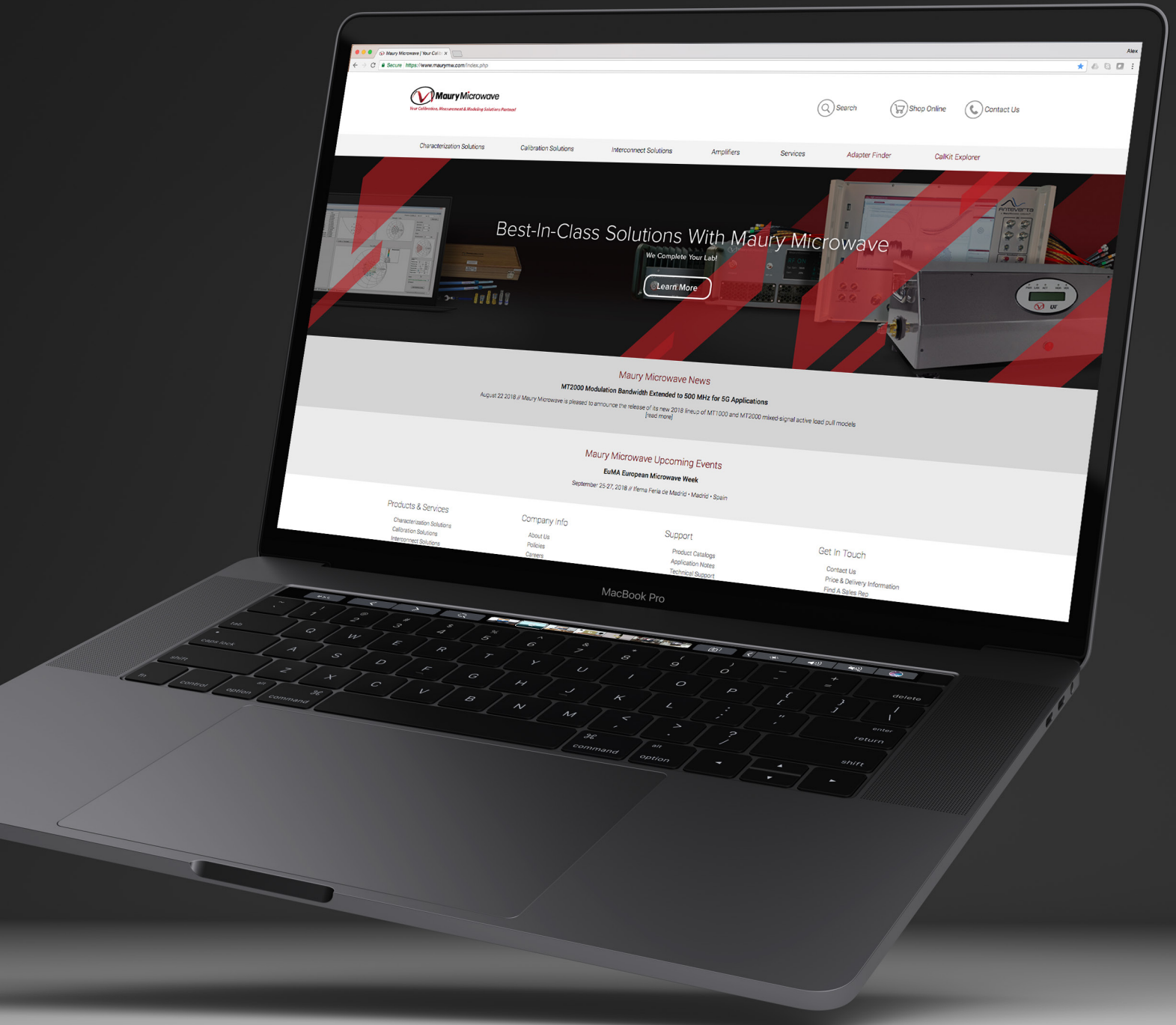

www.maurymw.com



CONTACT US:

W / maurymw.com
E / maury@maurymw.com
P / +1-909-987-4715
F / +1-909-987-1112
2900 Inland Empire Blvd
Ontario, CA 91764

